

# MEGAPIX AI CAAS

Camera as a System with Next-Generation Video Analytics

DWC-XSDE08MCI 4K vandal dome IP camera with AI, x= storage size

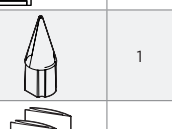
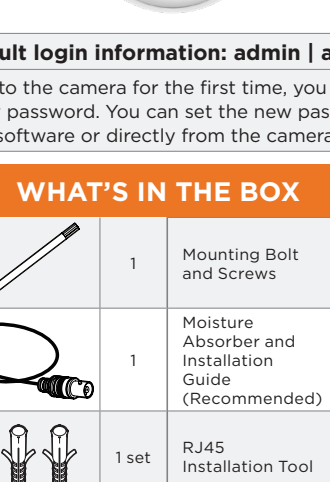

### Default login information: admin | Admin

When logging into the camera for the first time, you will be prompted to set up a new password. You can set the new password using the DW® IP Finder™ software or directly from the camera's browser menu.

### WHAT'S IN THE BOX

Star Wrench (T-20)		1	Mounting Bolt and Screws		1 set
Test Monitor Cable		1	Moisture Absorber and Installation Guide (Recommended)		1
Screws and Plastic Anchors - 2pcs		1 set	RJ45 Installation Tool		1
Mounting Template		1	Quick Setup and Download Guides		1 set
Grommet		1			

**NOTE:** Download all your support materials and tools in one place

- Go to: <http://www.digital-watchdog.com/resources>
- Search your product by entering the part number in the "Search by Product" search bar. Results for applicable part numbers will populate automatically based on the part number you enter.
- Click "Search". All supported materials, including manuals and quick start guide (QSGs) will appear in the results.

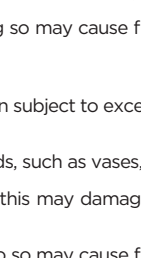

**Attention:** This document is intended to serve as a quick reference for the initial set-up. It is recommended that the user read the entire instruction manual for complete and proper installation and usage.

## SAFETY AND WARNING INFORMATION

Read through this Installation Guide carefully before installing the product. Keep the Installation Guide for future reference. See the user manual for more information on the proper installation, use and care of the product. These instructions are intended to ensure that users can use the product correctly to avoid danger or property loss. Warnings: Serious injury or death may occur if any of the warnings are neglected. Cautions: Injury or equipment damage may occur if any of the cautions are neglected.

### WARNING

- In the use of the product, you must be strict compliance with the electrical safety regulations of the nation and region. When the product is mounted on a wall or ceiling, the device shall be firmly fixed.
- Be sure to use only the standard adapter specified in the specification sheet. Using any other adapter could cause fire, electrical shock, or damage to the product.
- Make sure the power supply voltage is correct before using the camera.
- Incorrectly connecting the power supply or replacing the battery may cause an explosion, fire, electric shock, or damage to the product.
- Do not connect multiple cameras to a single adapter. Exceeding the capacity may cause excessive heat generation or fire.
- Securely plug the power cord into the power source. An insecure connection may cause a fire.
- When installing the camera, fasten it securely and firmly. A falling camera may cause personal injury.
- Do not install in humid, subject to elevated temperature, low temperature, or high humidity. Doing so may cause fire or electric shock.
- Do not place conductive objects (e.g. screwdrivers, coins, metal items, etc.) or containers filled with water on top of the camera. Doing so may cause personal injury due to fire, electric shock, or falling objects.
- Do not install in humid, dusty, or sandy locations. Doing so may cause fire or electric shock.
- Do not install near any heat sources such as radiators, heat registers, or other products (including amplifiers) that produce heat.
- Keep out of direct sunlight and heat radiation sources. It may cause a fire.
- If any unusual smells or odors come from the unit, stop using the product at once. Immediately disconnect the power source and contact the service center. Continued use in such a condition may cause fire or electric shock. If this product does not operate normally, contact the nearest service center. Never disassemble or change this product in any way.
- When cleaning the product, do not spray water directly onto parts of the product. Doing so may cause fire or electric shock.

### CAUTION

- Use proper safety gear when installing and wiring the product.
- Do not drop objects on the product or apply strong shock to it. Keep away from a location subject to excessive vibration or magnetic interference.
- Do not use this product near water.
- The product shall not be exposed to dripping or splashing and no objects filled with liquids, such as vases, shall be placed on the product.
- Avoid aiming the camera directly towards extremely bright objects such as the sun, as this may damage the image sensor.
- The Main plug is used as a disconnect device and shall stay readily operable at any time.
- Remove the power adapter from the outlet when then there is lightning. Neglecting to do so may cause fire or damage to the product.
- Do not block any ventilation openings. Install following the manufacturer's instructions.
- A polarized or grounding-type plug is recommended for this product. A polarized plug has two blades with one wider than the other. A grounding-type plug has two blades and a third grounding prong. If the provided plug does not fit into your outlet, consult an electrician for replacement.
- Protect the power cord from being walked on or pinched particularly at plugs, convenience receptacles, and the point where they exit from the product.
- If any laser equipment is used near the product, make sure the surface of the sensor is not exposed to the laser beam as that may damage the sensor module.
- If you want to move the already installed product, be sure to turn off the power and then move or reinstall it.
- Proper configuration of all passwords and other security settings is the responsibility of the installer and/or end-user.
- If cleaning is necessary, please use a clean cloth to wipe it gently. If the device will not be used for a long time, please cover the lens cap to protect the device from dirt.
- Do not touch the camera's lens or sensor module with fingers. If cleaning is necessary, please use a clean cloth to wipe it gently. If the device will not be used for a long time, please cover the lens cap to protect the device from dirt.
- Use only attachments/accessories specified by the manufacturer.
- Always use hardware (e.g. screws, anchors, bolts, locking nuts, etc.) compatible with the mounting surface and of sufficient length and construction to ensure a secure mount.
- Use only with cart, tripod, bracket, or table specified by the manufacturer, or sold with the product.
- Unplug this product when a cart is used. Use caution when moving the cart/product combination to avoid injury from tip-over.
- Refer all servicing to qualified service personnel. Servicing is needed when the product has been damaged in any way, such as power supply cord or plug is damaged, power source has been spilled or objects have fallen into the product, the product has been exposed to rain or moisture, does not operate normally, or has been dropped.

## STEP 1 - PREPARING TO MOUNT THE CAMERA

- For the installation, remove the dome using the wrench included with the camera to loosen the three (3) screws on the base of the dome. Remove the protection film between the dome and the camera module.

**WARNING DO NOT TOUCH THE BUBBLE.**  
CleanView™ Hydrophobic Dome Coating has been applied to the dome.

- Remove the existing moisture packet and insert the new packet in its place. The camera will generate enough heat to dry moisture during operation. In case of a moisture issue, keep the moisture absorber in the camera for up to six (6) months.

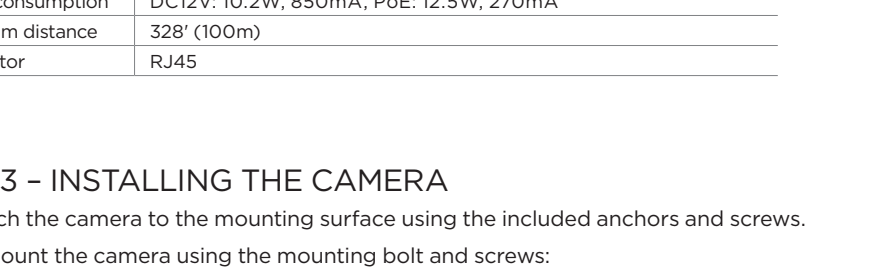

**WARNING:** The moisture absorber prevents moisture buildup inside the camera, which may cause image performance issues and damage the camera.

- Using the mounting template sheet or the camera itself, mark and drill the necessary holes in the mounting surface.

## STEP 2 - POWERING THE CAMERA

Pass the wires through and make all necessary connections.

Use a PoE Switch or PoE injector to connect data and power to the camera using a single Ethernet cable.

Use non-PoE Switch to connect data using and Ethernet cable and use a power adapter to power the camera.



Power information	
Power requirements	DC12V, PoE (IEEE 802.3af class 3). Adapter not Included.
Power consumption	DC12V: 10.2W, 850mA, PoE: 12.5W, 270mA
Maximum distance	328' (100m)
Connector	RJ45

## STEP 3 - INSTALLING THE CAMERA

- Attach the camera to the mounting surface using the included anchors and screws.
- To mount the camera using the mounting bolt and screws:
  - Secure the mounting screws to the camera's base.
  - Use the mounting nuts to secure the camera to the mounting surface.

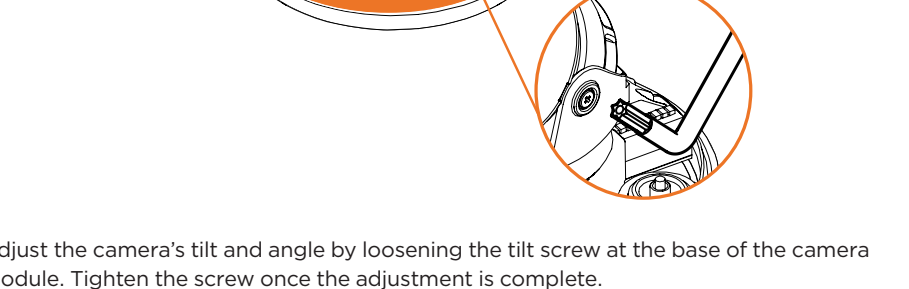

Tilting 75°  
Rotation 375°  
Panning 345°

- Adjust the camera's tilt and angle by loosening the tilt screw at the base of the camera module. Tighten the screw once the adjustment is complete.

**NOTE:** When setting up the camera for the first time, use the CALIBRATE button on the camera's web GUI to auto calibrate the camera's lens before operation.

- Assemble the dome cover over the camera body. Align the dome and bottom case to match the case outline.

**NOTE:** Be careful not to alter the direction of the camera module.

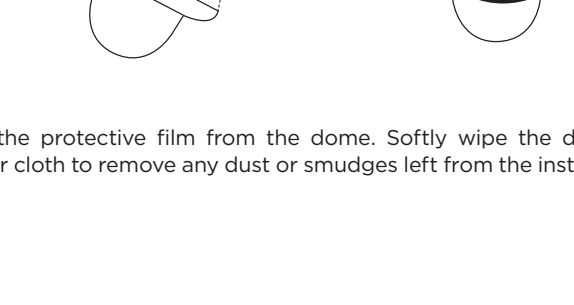

- Remove the protective film from the dome. Softly wipe the dome with lens tissue or a microfiber cloth to remove any dust or smudges left from the installation process.

**Reset Button**

**Resetting the camera:** With the camera powered ON, press the reset-button for five (5) seconds to initiate a camera-wide reset of all the settings, including network settings.

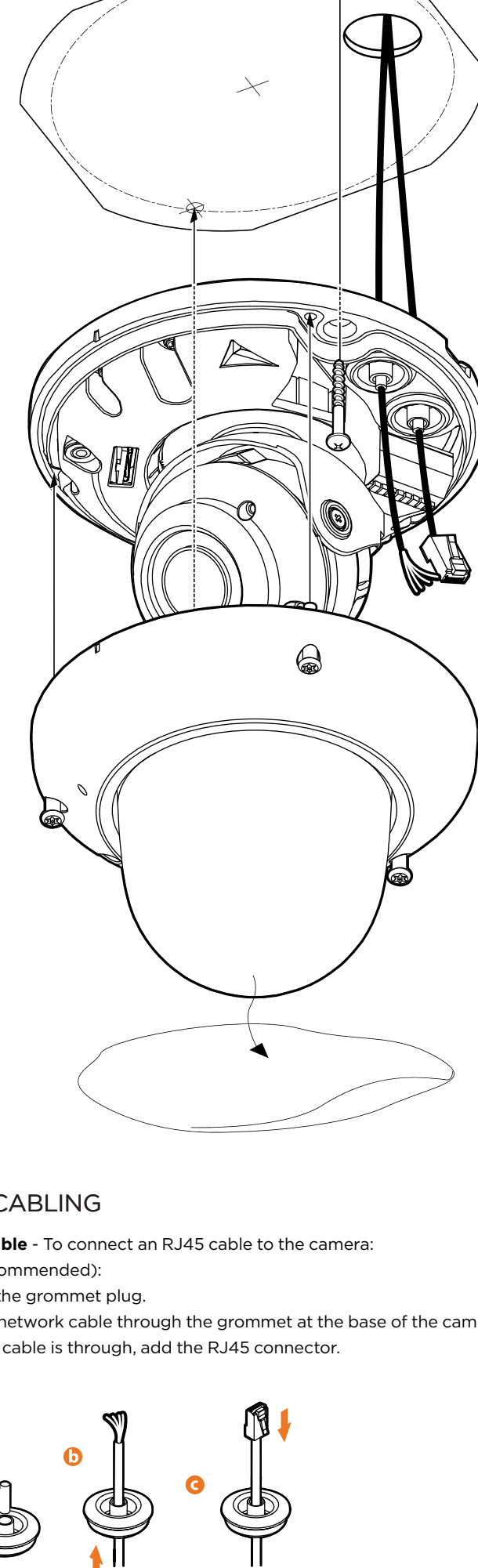

## STEP 4 - CABLING

- Network cable** - To connect an RJ45 cable to the camera:
  - Option A (Recommended):
    - Remove the grommet plug.
    - Pass the network cable through the grommet at the base of the camera.
    - Once the cable is through, add the RJ45 connector.

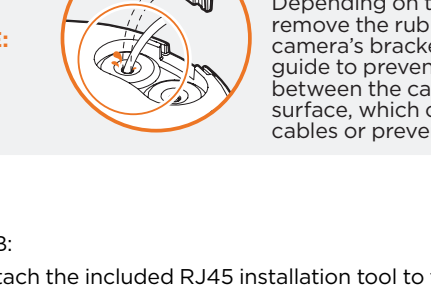

**NOTE:** Use the cable with a diameter of  $\varnothing 0.19'' - \varnothing 0.31''$  ( $\varnothing 5.0 - \varnothing 8.0\text{mm}$ ). Depending on the installation environment, remove the rubber plug on the side of the camera's bracket and use the gap as a cable guide to prevent cables from getting caught between the camera and the mounting surface, which can cause damage to the cables or prevent a proper mounting.

### Option B:

- Attach the included RJ45 installation tool to the network cable.
- Remove the grommet plug.
- Pass the network cable through the grommet. Pay attention to the direction of the grommet connection.
- Once the cable's connector is through, remove the installation tool.

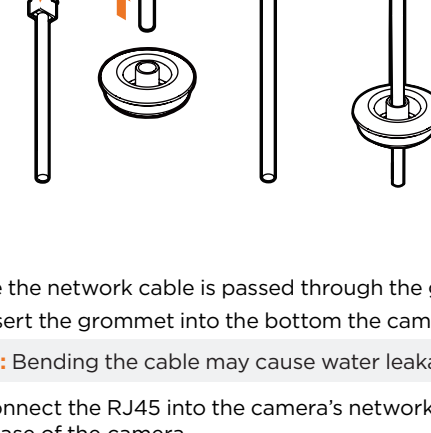

Once the network cable is passed through the grommet:
 

- Insert the grommet into the bottom of the camera.

**NOTE:** Bending the cable may cause water leakage.

- Connect the RJ45 into the camera's network input at the base of the camera.

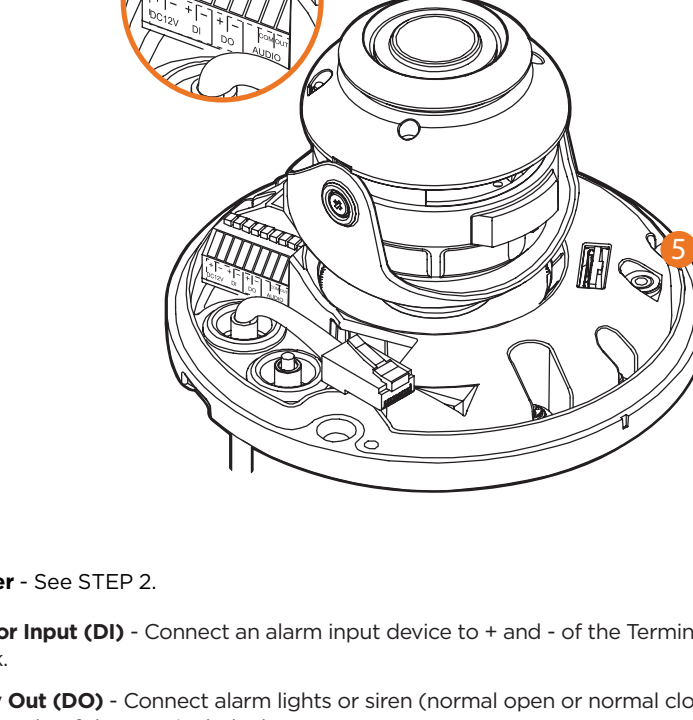

## STEP 5 - DW® IP FINDER™

Use the DW IP Finder software to scan the network and detect all MEGAPIX® cameras, set the camera's network settings or access the camera's web client.

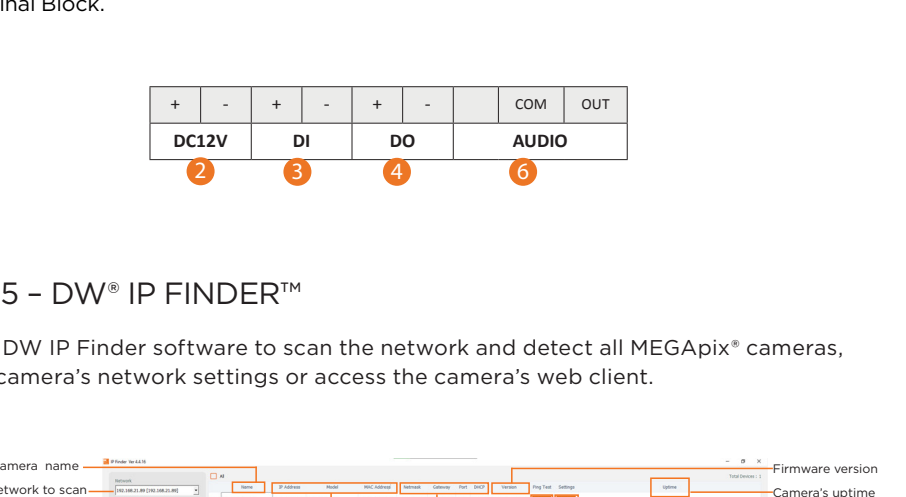

### Network set up

- To install the DW IP Finder, go to: <http://www.digital-watchdog.com>
- Enter "DW IP Finder" on the search box at the top of the page.
- Go to the "Software" tab on the DW IP Finder page to download and install the installation file.
- Open the DW IP Finder and click "Scan Devices". It will scan the selected network for all supported devices and list the results in the table. After the scan, the DW® logo will turn gray.
- When connecting to the camera for the first time, a password must be set.
  - Check the box next to the camera in the IP Finder's search results. You can select multiple cameras.
  - Click "Bulk Password Assign" on the left.
  - Enter admin/admin for the current username and password. Enter a new username and password to the right. Passwords must have a minimum of eight (8) characters and at least four (4) combinations of uppercase and lowercase letters, numbers and special characters. Passwords cannot contain the user ID.
  - Click "change" to apply all changes.

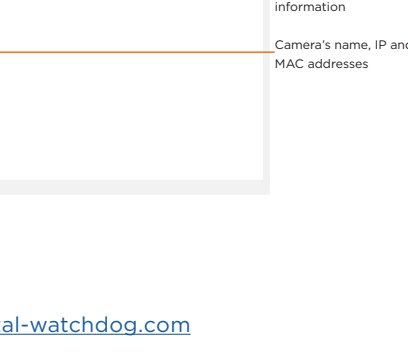

- Select a camera from the list by double-clicking on the camera's name or clicking on the "Click" button. The pop-up window will show the camera's current network settings. Admin users can adjust the settings as needed. The camera's network settings are set to DHCP by default.
- To access the camera's web page, click on the "Website" button.
- To save changes made to the camera's settings, enter the username and password of the camera's admin account and click "Apply".

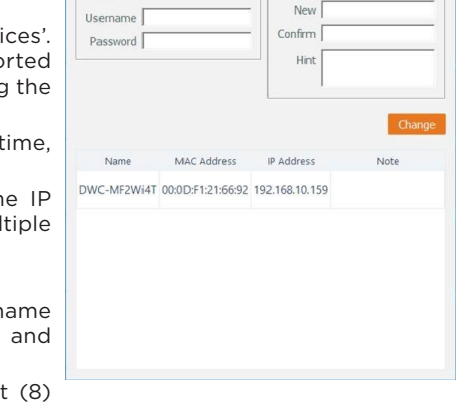

**NOTE:** Select "DHCP" for the camera to automatically receive its IP address from the DHCP server.

**NOTE:** Select "Static" to manually enter the camera's IP address, (Sub) Netmask, Gateway and DNS information.

**NOTE:** The camera's IP must be set to static if connecting to Spectrum® IPVMS.

**NOTE:** To access the camera from an external network, port forwarding must be set in your network's router.

## STEP 6 - WEB VIEWER

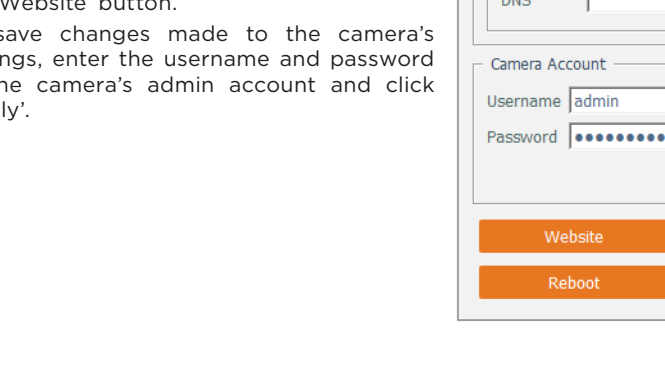

The GUI display may differ by camera models.

- Find the camera using the DW IP Finder.
- Double-click on the camera's view in the results table.
- Press the "View Camera Website".
- Enter the camera's username and password you set up in the DW IP Finder. If you did not set up a new username and password, a message will direct you to set up a new password for the camera to view the video.

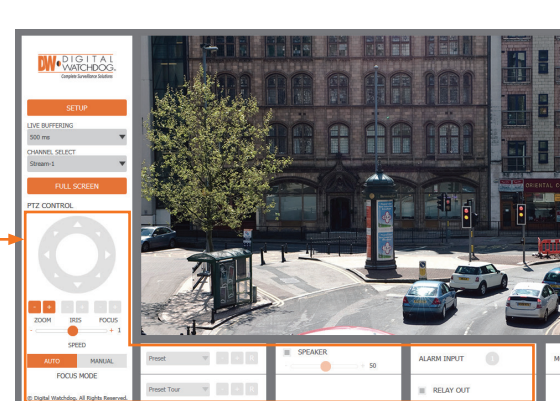

## STEP 7 - SET UP DW SPECTRUM® CAAS™

To complete the DW Spectrum® CaaS™ server's set up and start recording, see the DW Spectrum® CaaS™ QSG for additional information.

**NOTE:** Please see the full product manual for web viewer setup, functions and camera settings options.

**NOTE:** This product is covered by one or more claims of the HEVC Patents listed at [patentlist.accessdata.nvidia.com](http://patentlist.accessdata.nvidia.com).

